

REV	DESCRIPTION	DATE	APPR
A	ECN0823	21-DEC-20	JD

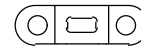

Clamp: CR Steel w/zinc plating

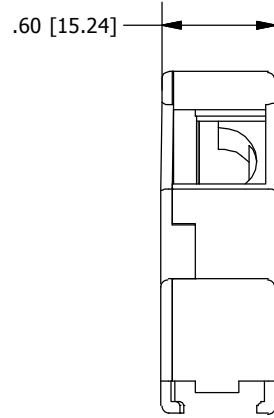
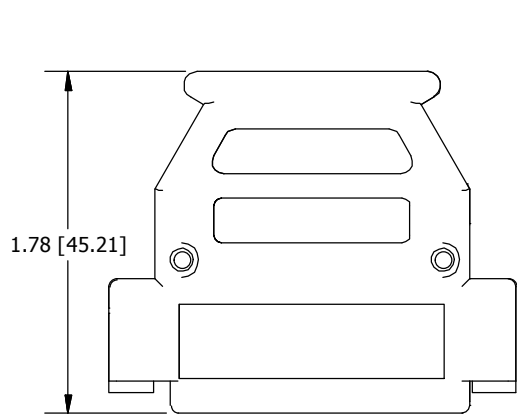

Assembly Screw: CR Steel w/zinc plating



Thumbscrew: steel w/zinc plating



#4-40 UNC

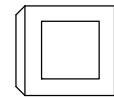

Blanking Plate: Plastic
Black for N300BK0025S
Metalized Plastic for N300MP0025S

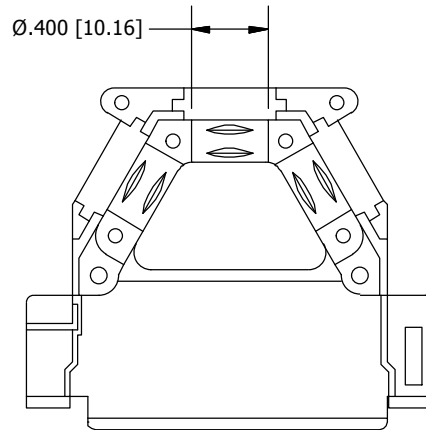
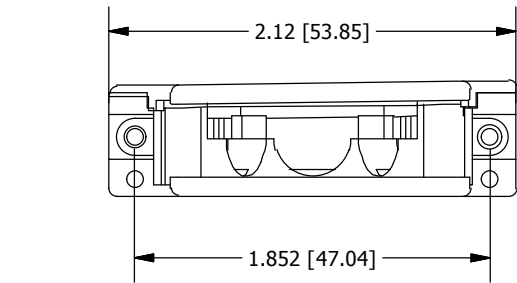

- Kit consists of:
- 1 - cover top
 - 1 - cover bottom
 - 2 - thumbscrews
 - 4 - assembly screws
 - 1 - cable clamp
 - 2 - Blanking Plates

PART NUMBERS:
Black Plastic - N300BK0025S
Metalized Plastic - N300MP0025S

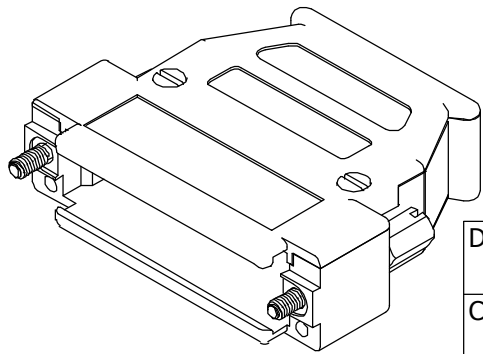

DRAWN	JSD	07-APR-15
CHECKED	SCN	07-APR-15
ISSUED		07-APR-15

Northern Technologies

THIS DRAWING IS THE PROPERTY OF NORTHERN TECHNOLOGIES AND SHOULD NOT BE REPRODUCED WITHOUT NORTHERN TECHNOLOGIES WRITTEN PERMISSION.

PART NUMBER SEE PART NUMBER INFORMATION
DESCRIPTION CPP3/CMP3 25 3WAY EXIT

UNLESS OTHERWISE SPECIFIED
DIMENSIONS ARE IN INCHES [MM]
TOLERANCE .XXX ± .010 [0.254]
.XX ± .020 [0.508]
.X ± .030 [0.762]
ANGULAR ± 1½°

SIZE	CODE	DWG NO.	REV
A	200_285	0002-200-285	-
SCALE	N.T.S.	SHEET 1 OF 1	

THIS IS A CONTROLLED DOCUMENT AND IS SUBJECT TO CHANGE. CONTACT NORTHERN TECHNOLOGIES ENGINEERING FOR THE LATEST REVISION.