

REV	DATE	DESCRIPTION	APP
A	07-DEC-15	ECN 0781	

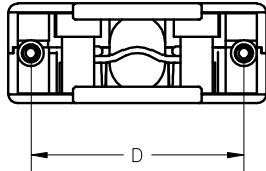
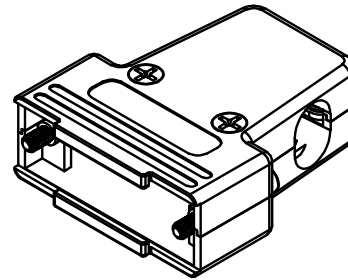
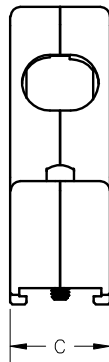
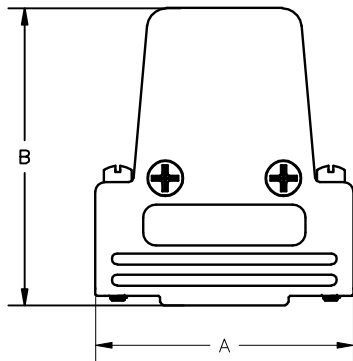

**DIMENSIONS**

A:	1.587 ±0.051	[40.30 ±1.30]
B:	1.780 ±0.051	[45.20 ±1.30]
C:	0.591 ±0.047	[15.00 ±1.20]
D:	1.312 ±0.010	[33.32 ±0.25]

ORDER INFORMATION	
PART NUMBER	JACK SCREW THREAD TYPE
MHETRIM15MK	#4-40 UNC CLASS 2A
MHETRIM15M25K	M2.5 X .45mm PITCH
MHETRIM15M3K	M3 X .5mm PITCH

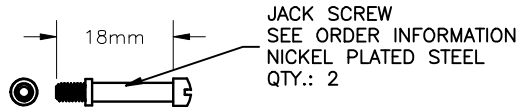
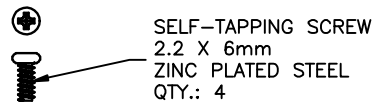
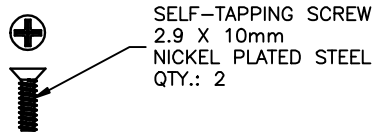
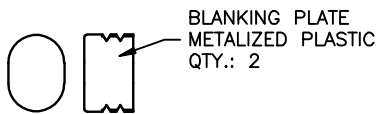
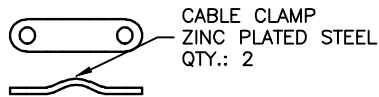

**NOTES:**

- COVER MATERIAL: ABS
- COVER FINISH: NICKEL OVER COPPER
- OPERATING TEMPERATURE: -55°C TO +110°C
- MAX. CABLE O.D.: 0.512 Inches [13mm]

THIS IS A CONTROLLED DOCUMENT AND IS SUBJECT TO CHANGE. CONTACT NORTHERN TECHNOLOGIES ENGINEERING FOR THE LATEST REVISION.

UNLESS OTHERWISE SPECIFIED	SIGNATURES	DATE	Northern Technologies <small>THIS DRAWING IS THE PROPERTY OF NORTHERN TECHNOLOGIES AND SHOULD NOT BE REPRODUCED WITHOUT NORTHERN TECHNOLOGIES WRITTEN PERMISSION.</small>		
1. DIMENSIONS IN INCHES [MM] 2. TOLERANCE: AS SHOWN 3. ANGLES ±1°	DRAWN Luis C.	22-JUN-11	PART NUMBER SEE ORDER INFORMATION		
	CHECKED JSD	22-JUN-11	DESCRIPTION CMP 15 3-WAY EXIT COVER KIT		
	ENG		SHEET 1	CODE 7100_271	DWG NO. 7100-500-271
	ISSUED	29-JUN-11	SCALE N.T.S. SHEET 1 OF 1		