

REVISIONS				
ZONE	REV	DESCRIPTION	DATE	APPROVED
	A	ECN 0581	07-OCT-05	
	B	ECN 0587	14-NOV-05	

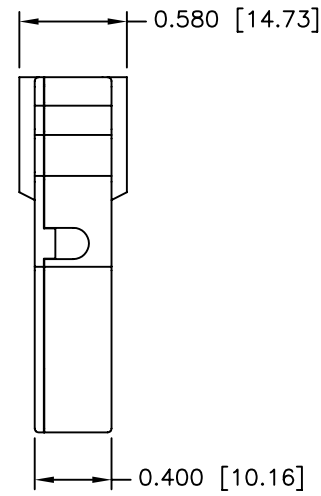
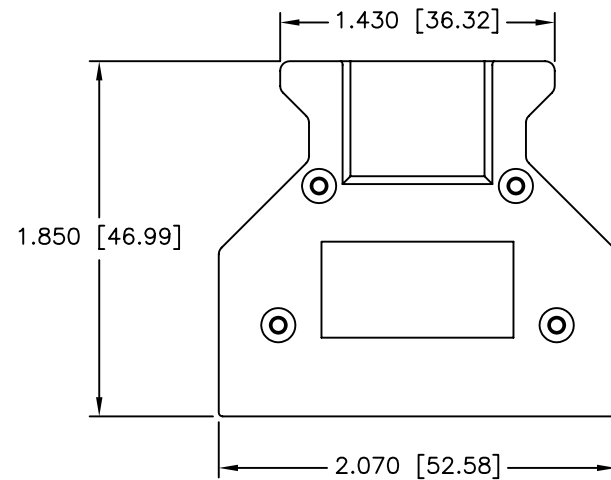
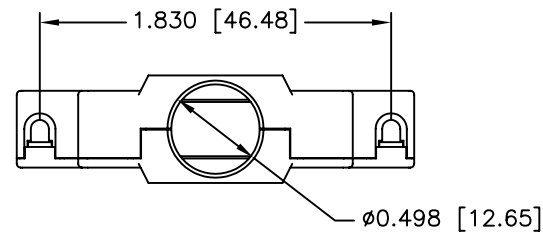

CONNECTOR COVER:

- 1.MATERIAL: ZINC ALLOY
- 2.FINISH: NICKEL PLATING PER NTC SPECIFICATION N/T 000400
- 3.DIMENSIONS: INCHES [MM]
- 4.TOLERANCE: ± 0.015 [0.381]

COMPRESSION INSERT TREE

- 1.MATERIAL: THERMOPLASTIC PVC COMPOUND
- 2.COLOR: BLACK
- 3.DUROMETER: 75 ± 5 TYPE A PER ASTM D2240
- 4.DIMENSIONS: INCHES [MM]
- 5.TOLERANCE: ± 0.020 [0.508]

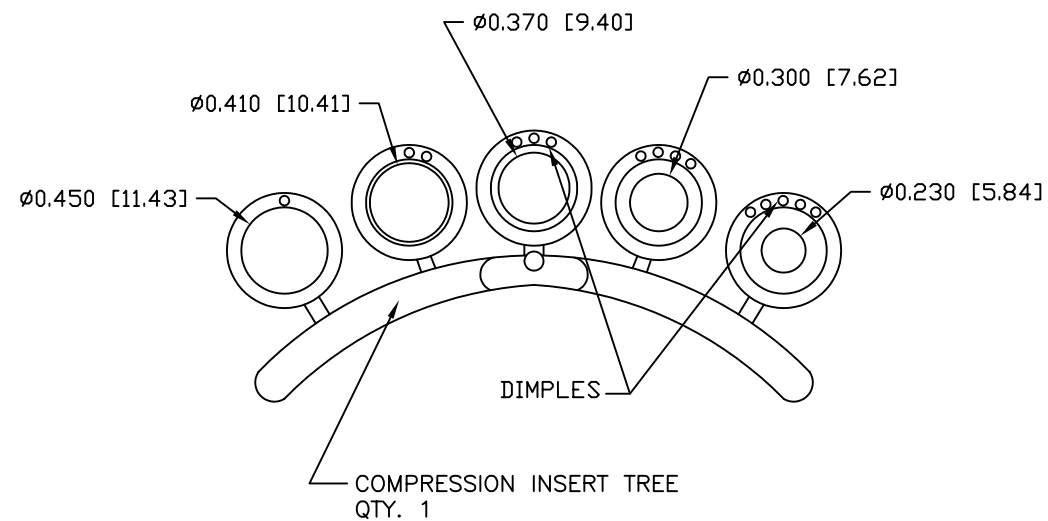

#2-56 UNC STAINLESS STEEL THUMBSCREW WITH PVC KNOB
QTY: 2 EACH

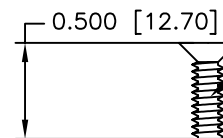

#2-56 UNC PHILLIPS HEAD MACHINE SCREW - STAINLESS STEEL
QTY: 4 EACH

NO LOGO

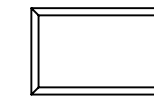

PART NUMBER INFORMATION

PART#	LOGO STYLE	SUPPLIED
NA90E110000	NO LOGO TOP COVER	BULK
NA90E110100	BOTTOM COVER	BULK
N90E110000	NO LOGO	PACKAGED

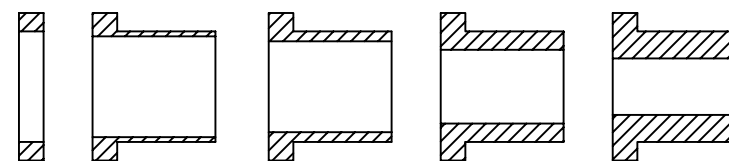

THIS IS A CONTROLLED DOCUMENT AND IS SUBJECT TO CHANGE. CONTACT NORTHERN TECHNOLOGIES ENGINEERING FOR THE LATEST REVISION.

UNLESS OTHERWISE SPECIFIED		Northern Technologies			THIS DRAWING IS THE PROPERTY OF NORTHERN TECHNOLOGIES AND SHOULD NOT BE REPRODUCED WITHOUT NORTHERN TECHNOLOGIES WRITTEN PERMISSION.	
1. ALL DIMENSIONS ARE IN INCHES (MM) 2. DIMENSIONS ARE TYPICAL		PART NUMBER SEE PART NUMBER INFORMATION				
DRAWN JSD 30-MAR-05		DESCRIPTION CMHD 50 STR EXIT COVER W/THUMBSCREWS				
CHECKED SCN 30-MAR-05	SIZE B	CODE 200_144	DWG NO. 0002-200-144	REV		
ISSUED 01-SEP-05	SCALE 1:1	SHEET 1 OF 1				