

REVISIONS				
ZONE	REV	DESCRIPTION	DATE	APPROVED
	A	ECN 0755	12-NOV-14	
	B	ECN 0757	18-NOV-14	

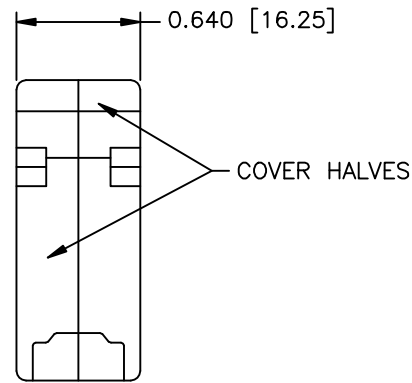

PART NUMBER INFORMATION

PART#	LOGO STYLE	SUPPLIED
C88E309000	NORTECH LOGO	PACKAGED
A30E309000	NORTECH LOGO	BULK

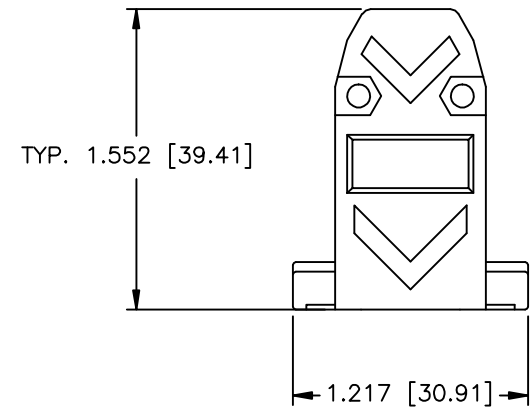
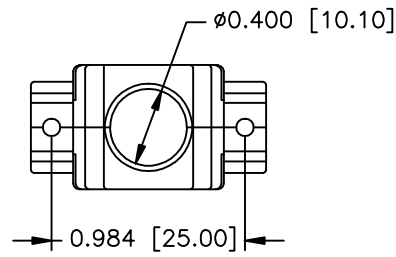
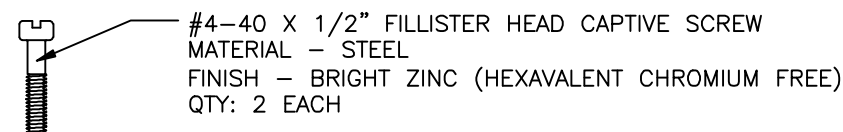
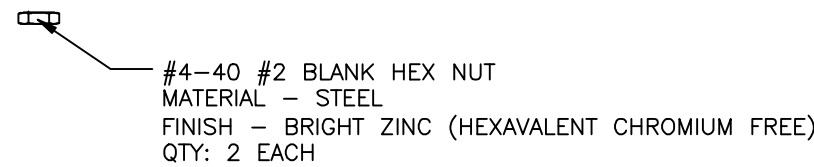
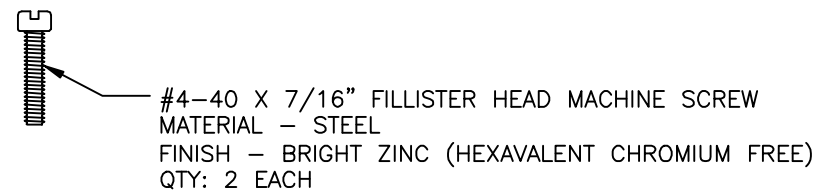
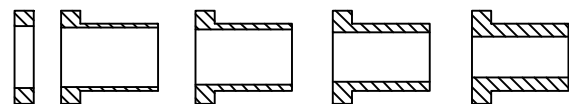
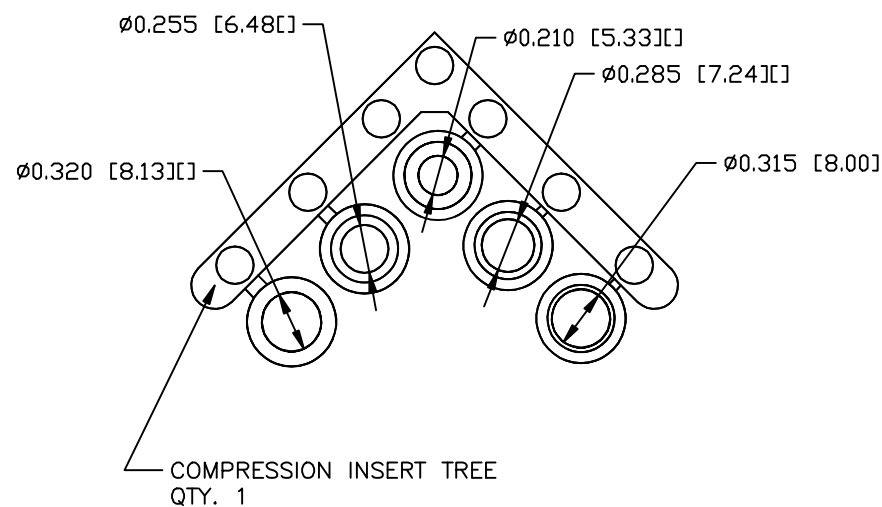

CONNECTOR COVER:

- 1.MATERIAL: ABS COMPOUND - UL94HB
- 2.FINISH: NICKEL PLATING PER NTC SPECIFICATION N/T 000500
- 3.DIMENSIONS: INCHES [MM]
- 4.TOLERANCE: ±0.015 [0.381]

COMPRESSION INSERT TREE

- 1.MATERIAL: THERMOPLASTIC
- 2.COLOR: BLACK
- 3.DUROMETER: 75 ±5 TYPE A PER ASTM D2240
- 4.DIMENSIONS: INCHES [MM]
- 5.TOLERANCE: ±0.020 [0.508]

THIS IS A CONTROLLED DOCUMENT AND IS SUBJECT TO CHANGE. CONTACT NORTHERN TECHNOLOGIES ENGINEERING FOR THE LATEST REVISION.

UNLESS OTHERWISE SPECIFIED 1. ALL DIMENSIONS ARE IN INCHES (MM) 2. DIMENSIONS ARE TYPICAL		<b>Northern Technologies</b> THIS DRAWING IS THE PROPERTY OF NORTHERN TECHNOLOGIES AND SHOULD NOT BE REPRODUCED WITHOUT NORTHERN TECHNOLOGIES WRITTEN PERMISSION.		
DRAWN JSD		PART NUMBER SEE PART NUMBER INFORMATION		
14-AUG-06		DESCRIPTION CMP 09 STR EXIT TWO PIECE FLANGELESS METALIZED PLASTIC COVER		
CHECKED SCN	14-AUG-06	SIZE B	CODE 200_131F	DWG NO. 0002-200-131F
ISSUED	14-AUG-06	SCALETNS		REV
			SHEET 1 OF 1	